

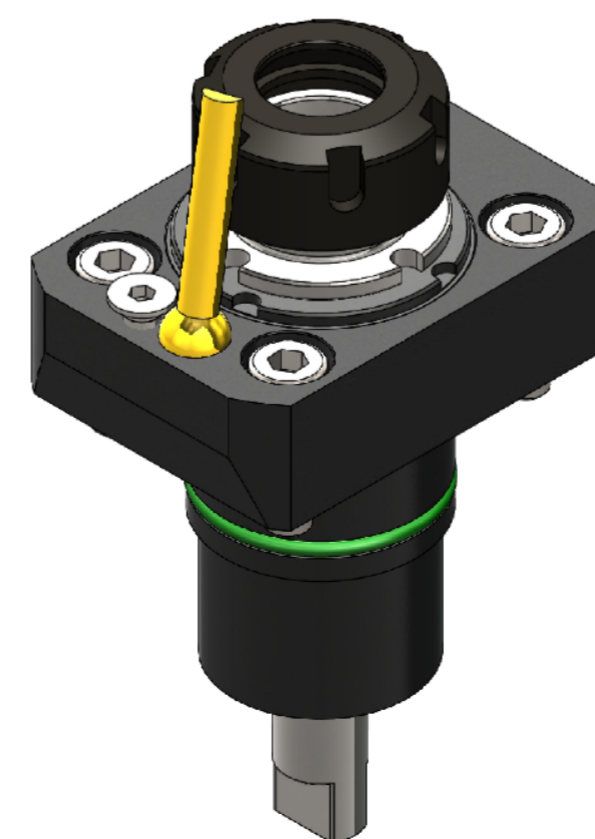

Chiave albero
Shaft wrench



▼ Senso di rotazione uguale al mandrino
Direction of rotation same as machine spindle

 GERARDI GERARDI S.P.A. Lonate Pozzolo (VA) Italy Tel. +39-0331-303911 Fax. +39-0331-301534	Motorizzato per torretta Driven tool for turret	NAKAMURA BMT44	
	Denominazione Denomination	Motorizzato Assiale Axial Driven tool	Refr. Esterno External Cool.
Portapinza Collet chuck ER-25 - Ø1÷16	Modello Model AXIAL	Potenza max Max power 6 kw	Data Date 10/06/2019
N° giri RPM max 6.000	Rapp. trasmis. Ratio 1:1	Coppia max Max Torque 40 Nm	N° disegno Code 99.NK.A40

Questo disegno e' di esclusiva proprietà della GERARDI S.P.A. la quale ne vieta la copia, la riproduzione e la cessione a terzi a norma di legge.
This drawing is of GERARDI S.P.A. exclusive property. The reproduction and use by others is forbidden by law.